



ABSORPTIVE SWITCH

MVE9226

Solid-State, SPDT

Features

- ✓ Wide Band Operation 30-90GHz
- ✓ Impedance :50ohm
- ✓ TTL Compatible driver include
- ✓ Low Insertion Loss / High Isolation

SPECIFICATIONS

PARAMETERS	MIN.	TYP.	MAX.	MIN.	TYP.	MAX.
FREQUENCY RANGE	30-60GHz			60-90GHz		
VSWR		3.0:1	3.5:1		2.5:1	3.0:1
INSERTION LOSS MAX.		10dB	11dB		13dB	14dB
ISOLATION MIN.	25dB	30dB		25dB	30dB	
RF INPUT POWER (CW)			15dBm			15dBm
DC POWER DISSIPATION (CW)		0.1W			0.1W	
0.1 dB Compression P0.1dB		15 dBm			15 dBm	
IIP3		38 dBm			35 dBm	
SWITCHING SPEED		250 ns	350 ns		250 ns	350 ns
BIAS CURRENT(+5V/-5V)	10/10 mA MAX.					
OPERATIONAL TEMPERATURE	-40°C~+85°C					
STORAGE TEMPERATURE	-50°C~+105°C					
ALTITUDE	30,000 ft. (Epoxy Seal Controlled environment)					
(OPTIONAL)	60,000 ft. 1.0psi min (Hermetically Seal Uncontrolled environment)					
VIBRATION	25g rms (15 degree 2KHz) endurance, 1 hour per axis					
HUMIDITY	100% RH at 35°C, 95% RH at 40°C					
SHOCK	20G for 11msec half sin wave, 3 axis both directions					
CONNECTORS	1.0mm Female					
MATERIAL / FINISHING	Aluminum / Gold Plated					



Tolerance:±0.3mm

OUTLINE DRAWING: (mm)

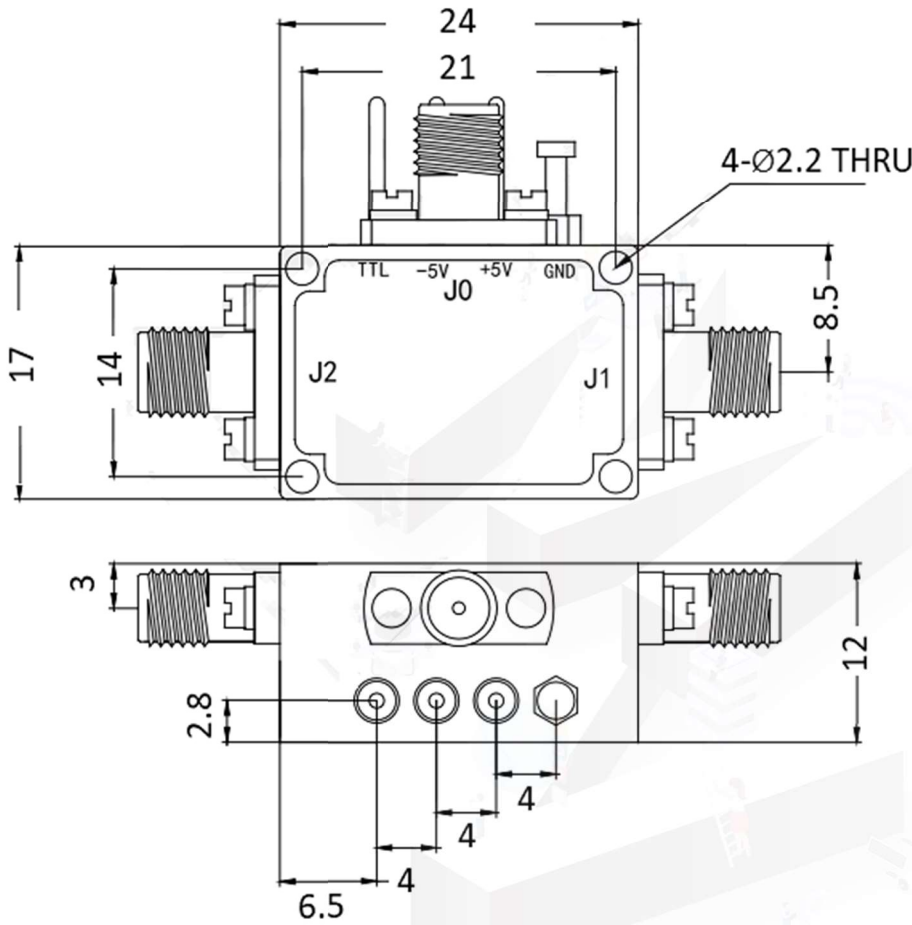

TRUTH TABLE	
Control Input TTL	Signal Path State
1	J0-J1
0	J0-J2
Control Pin	
Customization available upon request	

Absolute Max. Ratings <small>Design to meet the Spec.</small>	
Biasing	+5V/-5V±10%
TTL Control Voltage	0-0.8V/2.8-5V
Operating Temp.	-40°C~+85°C
Storage Temp.	-50°C~+105°C



Typical Test Result

Insertion loss@+25°C(30~60GHz)

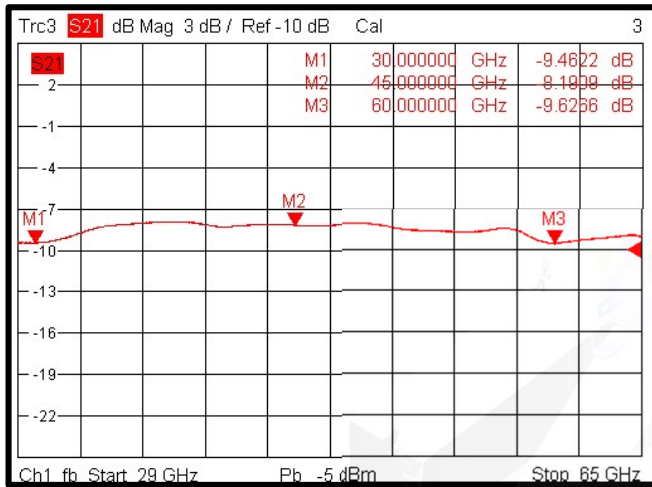

Input VSWR@+25°C(30~60GHz)

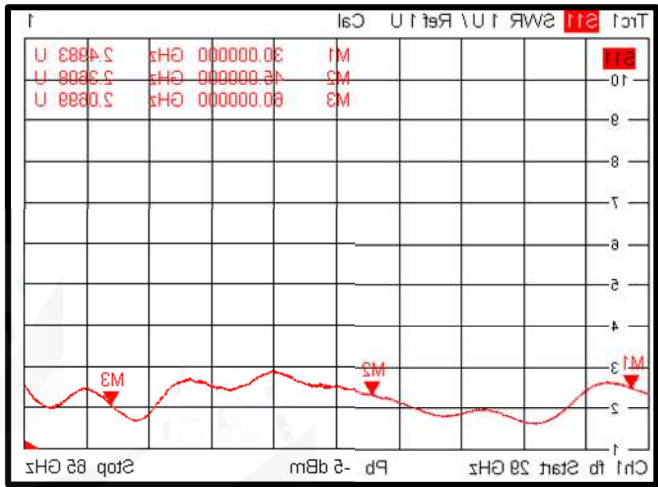

Output VSWR@+25°C(30~60GHz)

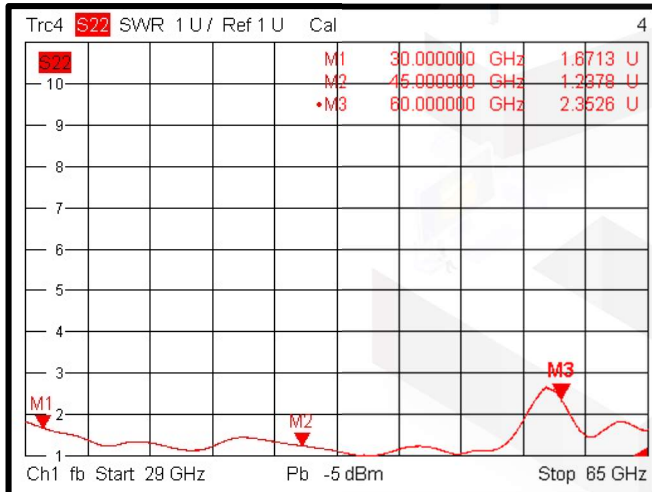

Isolation@+25°C(30~60GHz)

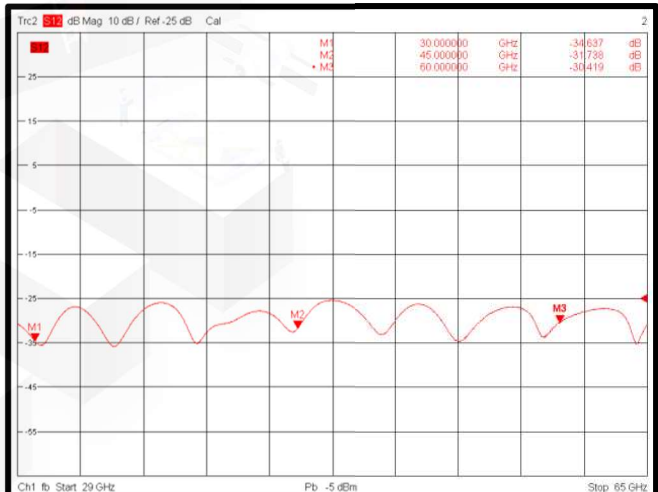



Insertion loss@+25°C(60~90GHz)

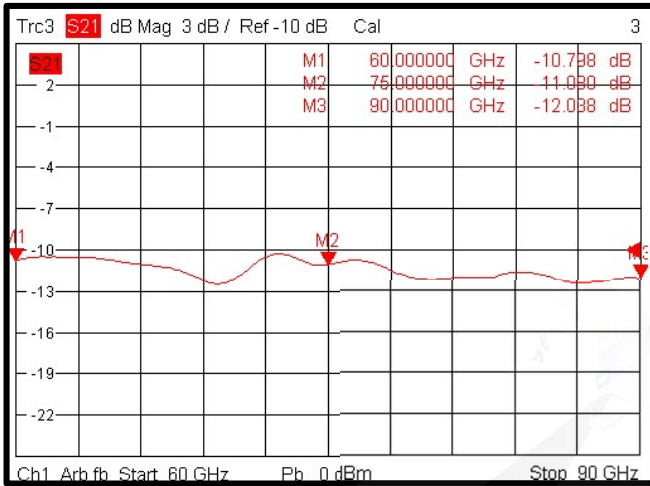

Input VSWR@+25°C(60~90GHz)

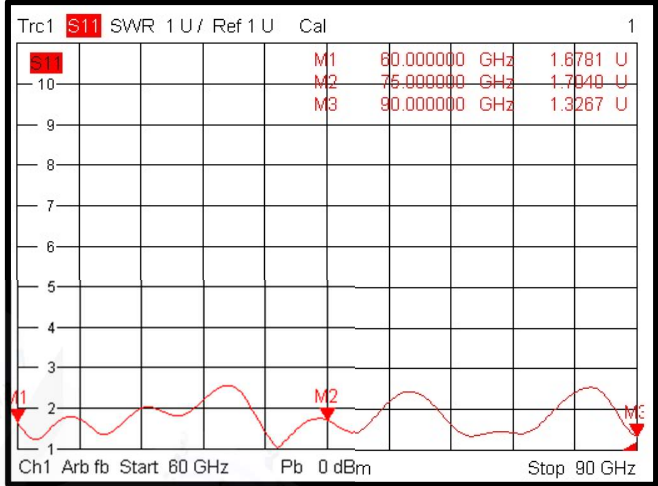

Output VSWR@+25°C(60~90GHz)

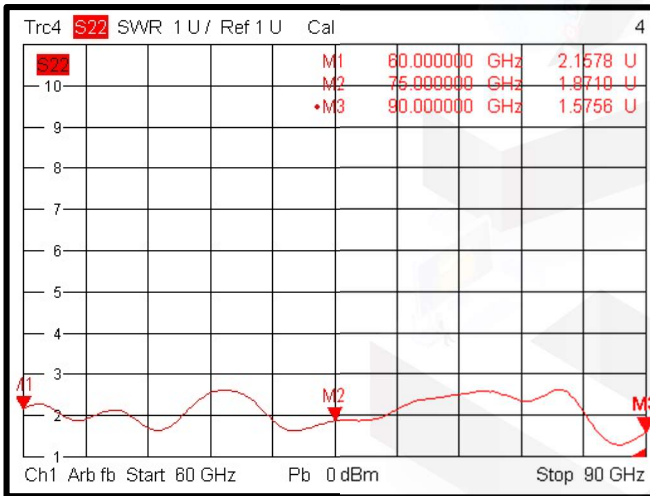

Isolation@+25°C(60~90GHz)

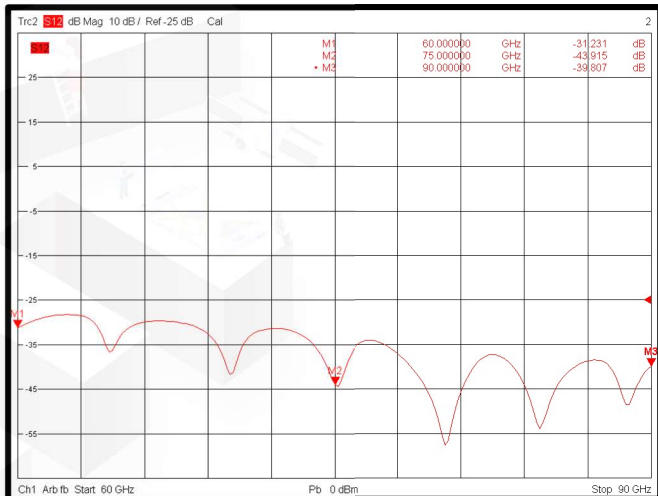

NOTES:

1. ALL SPECIFICATIONS ARE SUBJECT TO CHANGE WITHOUT NOTICE AT ANY TIME
2. CUSTOMER OUTLINE DRAWING FOR REFERENCE ONLY