

NOTCH FILTER

MFN-30000.31000.V1

30000MHz~31000MHz (REJECT BAND)



MVE's Notch filter can cut the guard band and preserve the band which you need in the specified frequency range. This type of filter is especially useful since you want to cut the band which is so closed to the in band. The products possess so superior performance with rejection.

SPECIFICATIONS:

Part Number	MFN-30000.31000.V1
Reject Band	30000MHz~31000MHz
Pass Band	DC~29000MHz; 32000~40000MHz
Insertion Loss	2.5 dB MAX.
Attenuation	60 dB MIN.
VSWR	2.0:1 MAX.
Average Power	10W MAX.
Connector Type	2.92mm Female
Operational Temperature	0°C~+50°C
Size	35mm x 17mm x 10mm

Tolerance: ±0.5mm

Outline Drawing (Unit: mm)

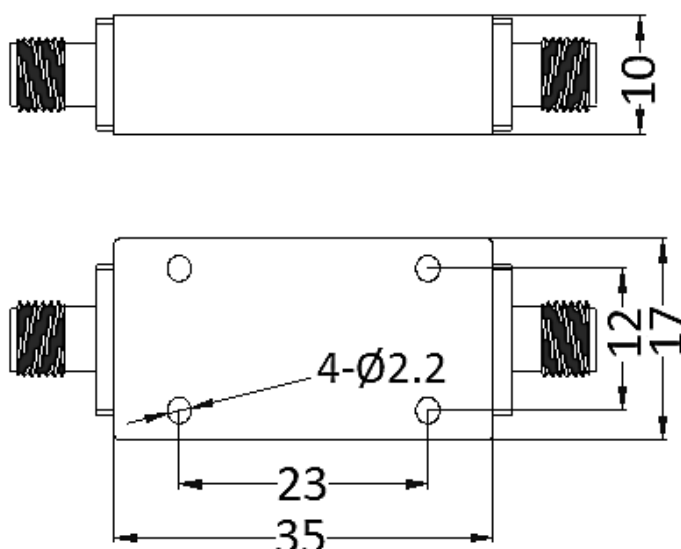

Typical Test Result



NOTES:

1. ALL SPECIFICATIONS ARE SUBJECT TO CHANGE WITHOUT NOTICE AT ANY TIME
2. CUSTOMER OUTLINE DRAWING FOR REFERENCE ONLY

